

FenceGuards™, Rail Padding & Fence Slats

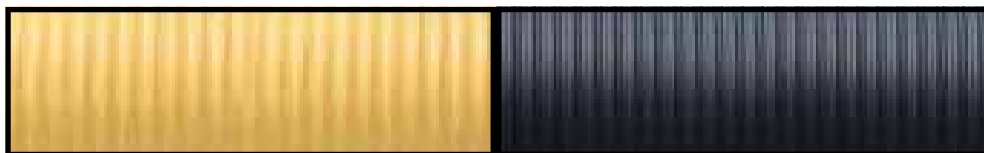

Fence Guards	2
Econo Guards (Corrugated / Poly-Cap)	3
Fence Crowns	3
Safety Top Caps	4
Foam Guards.....	5
Rail & Post Padding	6-8
Privacy / Chain Link Fence Slats	9-13

YOUR "ONE-STOP" SOURCE FOR AMERICA'S BASEBALL, SOFTBALL & SPORTS SURFACES & SUPPLIES!

PRICES SUBJECT TO CHANGE & AVAILABILITY PLUS SHIPPING | VOLUME DISCOUNTS AVAILABLE | COOPERATIVE PURCHASING CONTRACT PRICING FOR 50 STATES

BEAM CLAY®

WHOLESALE PRICE LIST
EFFECTIVE: JANUARY 1, 2023

Fence Guard Protective Covers for the Top Rail of Chain Link Fences

FENCE GUARDS™ Heavy-duty, UV-resistant MDPE polyethylene. Twelve 7-foot sections (84") per carton with pre-drilled holes every 2' for securing to fence; and includes ties for securing to fence; full cartons only.

PRICE

PREMIUM FENCE GUARDS™

3" W x 4-1/2" H x 7' Long x .1" wall.

SAFETY YELLOW—#01166-YEL7, Dark Green—#01166-GRN7, Red—#01166-RED7, or Blue—#01166-BLU7.
5-Year Limited Manufacturer's Warranty.

\$245/Box

STANDARD FENCE GUARDS™

2-5/8" W x 4" H x 7' Long x .07" wall.

SAFETY YELLOW—#01923-YEL7, Dark Green—#01923-GRN7, Red—#01923-RED7, White—#01923-WHT7, Blue—#01923-BLU7, or Orange—#01923-ORA7.
3-Year Limited Manufacturer's Warranty.

\$165/Box

LITE FENCE GUARDS™

2-5/8" W x 4" H x 7' Long x .05" wall.

SAFETY YELLOW—#03022-YEL7, Dark Green—#03022-GRN7, or Red—#03022-RED7.
1-Year Limited Manufacturer's Warranty.

\$120/Box

Extra Packs of 100 - 8" Black UV-Resistant Ties **#PT-8BK**

\$10.00/Pk



**3 Grades
&
6 Colors!**



YOUR "ONE-STOP" SOURCE FOR AMERICA'S BASEBALL, SOFTBALL & SPORTS SURFACES & SUPPLIES!

PRICES SUBJECT TO CHANGE & AVAILABILITY PLUS SHIPPING | VOLUME DISCOUNTS AVAILABLE | COOPERATIVE PURCHASING CONTRACT PRICING FOR 50 STATES

PARTAC PEAT CORPORATION
ONE KELSEY PARK, GREAT MEADOWS, NEW JERSEY 07838

800-247-BEAM (2326) • (908) 637-4191 • FAX (908) 637-8421
www.beamclay.com • sales@beamclay.com

CORRUGATED FENCE CAP *Safety Yellow, Golden-Yellow, Green, Black & Red***POLYCAP** *Yellow-Gold or Black*

The Original (Hi-Rib) Poly Cap. Pre-slit weather-treated and UV protected corrugated 100% virgin high density polyethylene in rolls, 4" ID x 4-1/2" OD x .040" wall thickness. Fasten with matching 19" yellow plastic ties (not included) at beginning and end and every 3-5'. 3-Year Limited Manufacturer's Warranty. Ships by common carrier in cardboard box. F.O.B. IN

250' Roll Yellow #POLYCAP250-YEL or Black #POLYCAP250-BLK	\$235
100' Roll Yellow #POLYCAP100-YEL or Black #POLYCAP100-BLK	\$110
19" UV-resistant, reusable Plastic Ties per 100—Yellow #L1950YW100 or Black #L1950UV100	\$22
Zipper Installation Tool #ZIPPER	\$75

PLASTICAP *Athletic Gold-Yellow, Black, Red or Green*

4-1/2" diameter, .050" wall thickness, 100% virgin resin, Thicker walls for longer life, UV inhibitor to enhance long term appearance. Fasten with matching 18" yellow plastic ties (not included) at beginning and end and every 3-5'. 3-Year Limited Manufacturer's Warranty. F.O.B. TX

250' Roll #PLASTICAP250-(Y,B) - Athletic Gold-Yellow or Black	\$255
250' Roll #PLASTICAP250-(R,G) - Red or Green	\$268
100' Roll #PLASTICAP100-(Y,B) - Athletic Gold-Yellow or Black	\$115
100' Roll #PLASTICAP100-(R,G) - Red or Green	\$125
18" UV-resistant, reusable Plastic Ties per 100—Yellow #L1950YW100 or Black #L1950UV100	\$25
Zipper Installation Tool #FENCECAPZIPQ	\$84

ECONO GUARDS™ CORRUGATED FENCE CAP - Safety Yellow and Black

Pre-slit in lengths of 100' or 250' with rounded corner profile for added strength, 4½" heavy duty construction, .034" wall thickness - Weather, Mildew and UV treated, 100% virgin high density polyethylene. Fasten with matching 19" yellow plastic ties (not included) at beginning and end and every 3-5'. 3-Year Limited Manufacturer's Warranty. F.O.B. IN

250' Roll, 85 lbs. Safety Yellow #01162 or Black #04449	\$233
100' Roll, 35 lbs. Yellow #01160 or Black #04450	\$113
19" UV-resistant, reusable Plastic Ties per 100—Yellow #TYWRAPS-Y or Black #TYWRAPS-B	\$25
Zipper Installation Tool #ZIPTOOL	\$84

FENCE CROWN®

Bright Yellow, Black or Athletic Gold 4" ID x 4 1/2" OD., .0375" wall thickness. Fasten with yellow or black 19" plastic ties (not included) at beginning and end and every 3-5'. Ships by common carrier. F.O.B. PA

250' Roll—Bright Yellow # 5000047 , Black #5000049 or Athletic Gold #5000175	\$255
100' Roll—Bright Yellow # 5000046 , Black #5000048 or Athletic Gold #5000174	\$150
19" Tie Wraps—Bag of 100 - Black #RM5000051 , Yellow #RM5000050	\$33
Zipper Installation Tool #FENCETOOL	\$70



YOUR "ONE-STOP" SOURCE FOR AMERICA'S BASEBALL, SOFTBALL & SPORTS SURFACES & SUPPLIES!

PRICES SUBJECT TO CHANGE & AVAILABILITY PLUS SHIPPING | VOLUME DISCOUNTS AVAILABLE | COOPERATIVE PURCHASING CONTRACT PRICING FOR 50 STATES

PREMIUM SAFETY TOP CAPS™

Heavy-duty, rectangular, protective cover for top rails of chain link fencing. .07" HDPE Plastic with UV stabilizers. Secures with included hog rings through pre-drilled holes. 40 ft. per bag (includes 5—8' sections, 3 hole punched plus 15 hog rings), 20 lbs. **Stock color: Safety Yellow.** 10 standard colors (Dark Green, Royal Blue, Light Blue, Red, Redwood, Brown, Beige, Grey, Black, White): 1600' minimum (40 bag) order, 4-6 weeks lead time, no returns.

PREMIUM SAFETY YELLOW—stock color.

40'/BAG 1—39 bags

#PSC-Y-L1

\$105

40'/BAG 40—119 bags

#PSC-Y-L2

\$100

40'/BAG 120+ bags

#PSC-Y-L3

\$90

10 STANDARD COLORS—Dark Green, Royal Blue, Light Blue, Red, Redwood, Brown, Beige, Grey, Black, or White. 1600' minimum unless in stock (40 bag) order, 4-6 weeks lead time, no returns.

#PSC-SC-L3

\$125

CUSTOM COLORS

1600' minimum (40 bag) order, 6-8 weeks lead time, no returns.

#PSC-CC-L3

\$150

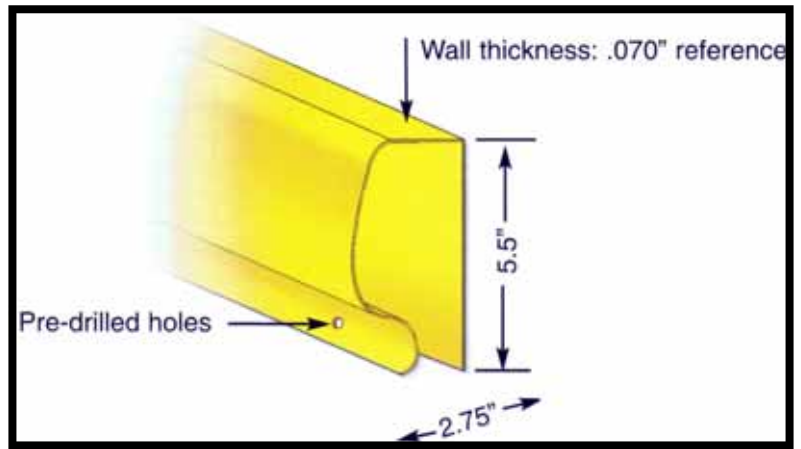
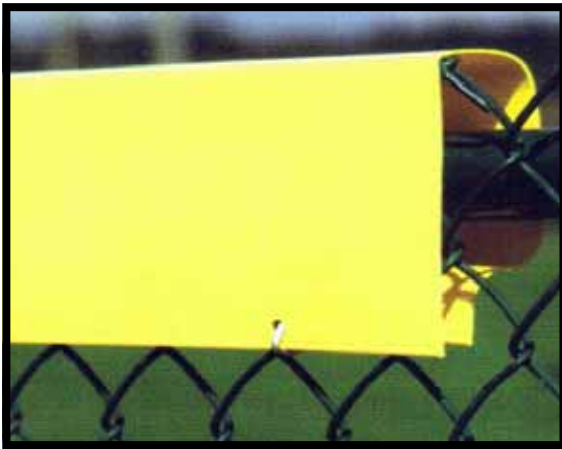

SAFETY TOP CAP—LITE™

- A Lighter, More Affordable Option for an open spec, 2.25"W x 4"H x 8' Long
- 10 - 8' pieces at 80' per bag / 4-hole punched with 40 Black Zip Ties included
- 40 bags per crate (3,200' coverage per crate)

SAFETY YELLOW (stock color)

80'/BAG 1—39 bags

#STCL-Y-L1

\$105

80'/BAG 40—119 bags

#STCL-Y-L2

\$95

80'/BAG 120+ bags

#STCL-Y-L3

\$90

10 STANDARD COLORS—Dark Green, Royal Blue, Sky Blue, Red, Redwood, Brown, Beige, Grey, Black, or White. 3,200' minimum (40 bag) order (unless in stock), 4-6 weeks lead time, no returns.

#STCLSC-L3

\$120

CUSTOM COLORS

3,200' minimum (40 bag) order, 6-8 weeks lead time, no returns.

#STCL-CC-L3

\$145



YOUR "ONE-STOP" SOURCE FOR AMERICA'S BASEBALL, SOFTBALL & SPORTS SURFACES & SUPPLIES!

PRICES SUBJECT TO CHANGE & AVAILABILITY PLUS SHIPPING | VOLUME DISCOUNTS AVAILABLE | COOPERATIVE PURCHASING CONTRACT PRICING FOR 50 STATES

BEAM CLAY®

WHOLESALE PRICE LIST
EFFECTIVE: JANUARY 1, 2023

Foam Guards™ & Safe Foam™ Rail Padding

FOAM GUARDS™ & SAFE FOAM™ RAIL PADDING

3/4" Thick x 8' Long Closed-Cell, Polyethylene Tubular Padding fits completely around any round pipe or rail 2.5" or less in diameter. Pre-slit for easy installation. Can be easily cut and mitered in the field for custom fit. No grommets—attach with plastic ties around outside of tube. Use with 3 colored plastic ties per straight length. Durable tough skin coating to prevent wear and UV-breakdown. 5-year manufacturer's warranty. Up to 15 lengths per UPS O.S. Box.

PREMIUM - With Tough Skin Coating. Available in Yellow, Green, Red, Royal Blue, Sky Blue, Black, Grey, Purple, 3-5/8" O.D. x 2-1/8" I.D. x 3/4" wall thickness. Yellow in stock. Other colors are custom ordered.

PREMIUM—8' Lengths

#SAFEFOAMPREMIUM

\$47/Length

STANDARD - 2" Wall Thickness Without Tough Skin Coating. Yellow only. 3-year manufacturer's warranty.

STANDARD— 8' Lengths

#RM5000067

\$39/Length

19" PLASTIC TIES

Yellow **#RM5000050** or Black **#RM5000051**.

Packs of 100

\$32/Pack

24" PLASTIC TIES

Natural/Off White for 2" Thick Pads **#RM000056**

\$29.65/Pack

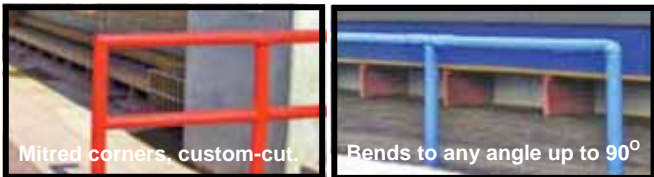
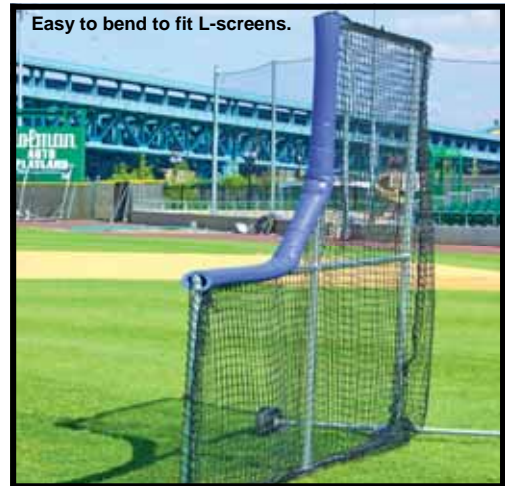

YOUR "ONE-STOP" SOURCE FOR AMERICA'S BASEBALL, SOFTBALL & SPORTS SURFACES & SUPPLIES!

PRICES SUBJECT TO CHANGE & AVAILABILITY PLUS SHIPPING | VOLUME DISCOUNTS AVAILABLE | COOPERATIVE PURCHASING CONTRACT PRICING FOR 50 STATES

CHAIN LINK FENCE TOP RAIL AND POST PADS

Designed to cover the dangerous vertical and horizontal posts and allow for view through the fence. Made of 3" high-density open cell foam fully encased in 18 oz. UV-resistant vinyl. Attach with nylon ties (not included) through grommets every 6".

Chain Link Top Rail Pad, 3" Foam, 9" face, 6" top, 1-1/2" flaps, grommets every 6"	#BCLTRPSG	\$40/LF
Chain Link Post Pad—Horizontal, 3" Foam, 6" wide w/1-1/2" flaps, grommets every 6"	#BCLPPSG	\$33/LF
Chain Link Post Pad—Vertical, 3" Foam, 6" wide w/1-1/2" flaps, grommets every 6"	#BCLPPSG	\$37/LF

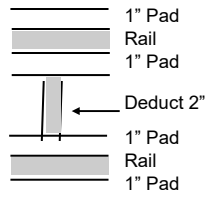
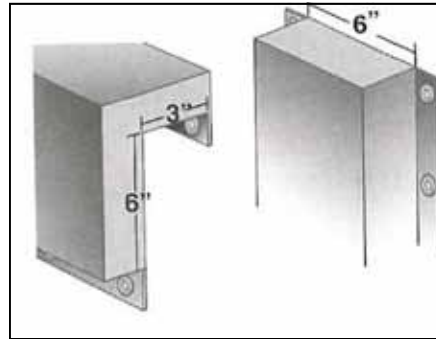

RAIL GUARDS™ DUGOUT RAIL PADDING

1" thick semi-rigid closed-cell polyethylene foam encased in 18 oz. vinyl with grommets every 6" for attachment to up to 2-1/2" diameter railing. Specify color Maple Green, Kelly Green, Royal Blue, Navy Blue, Sky Blue, Red, Orange, Yellow, White, Black, Grey, Tan, Purple, and Maroon.

#RAILPAD1X6	1" X 6'	\$145
#RAILPAD1X8	1" X 8'	\$185

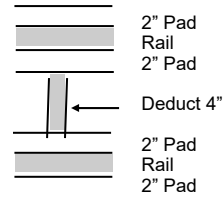

RAIL GUARDS™ RAIL & FENCE-TOP PADDING

2" thick semi-rigid closed-cell polyethylene foam fully encased in 18 oz. vinyl with grommets every 6" for attachment to up to 2-1/2" diameter railing. Specify color Maple Green, Kelly Green, Royal Blue, Navy Blue, Sky Blue, Red, Orange, Yellow, White, Black, Grey, Tan, Purple, and Maroon.

#RAILPAD2X6	2" X 6'	\$155
#RAILPAD2X8	2" X 8'	\$215

YOUR "ONE-STOP" SOURCE FOR AMERICA'S BASEBALL, SOFTBALL & SPORTS SURFACES & SUPPLIES!

PRICES SUBJECT TO CHANGE & AVAILABILITY PLUS SHIPPING | VOLUME DISCOUNTS AVAILABLE | COOPERATIVE PURCHASING CONTRACT PRICING FOR 50 STATES

AER-CUSHION FLAT RAIL PADDING			EACH
<i>(OPEN-CELL FOAM ENCASED IN 18 OZ. VINYL—18 COLORS)</i>			
Grommets spaced every 8" O.C. along two grommet flaps.			
16FRP	1" THICK FOAM X 6" WIDE (TO FIT UP TO 1" DIA. POLE)	LF	\$19
17FRP	1" THICK POLYFOAM X 7" WIDE (TO FIT UP TO 1.5" DIA. POLE)	LF	\$19.20
18FRP	1" THICK POLYFOAM X 8" WIDE (TO FIT UP TO 2" DIA. POLE)	LF	\$19.25
19FRP	1" THICK POLYFOAM X 9" WIDE (TO FIT UP TO 3" DIA. POLE)	LF	\$19.35
110FRP	1" THICK POLYFOAM X 10" WIDE (TO FIT UP TO 3.5" DIA. POLE)	LF	\$19.60
26FRP	2" THICK POLYFOAM X 6" WIDE (TO FIT UP TO 1" DIA. POLE)	LF	\$19.30
27FRP	2" THICK POLYFOAM X 7" WIDE (TO FIT UP TO 1.5" DIA. POLE)	LF	\$19.45
28FRP	2" THICK POLYFOAM X 8" WIDE (TO FIT UP TO 2" DIA. POLE)	LF	\$19.60
29FRP	2" THICK POLYFOAM X 9" WIDE (TO FIT UP TO 3" DIA. POLE)	LF	\$19.80
210FRP	2" THICK POLYFOAM X 10" WIDE (TO FIT UP TO 3.5" DIA. POLE)	LF	\$20.45

CHROMA-BOND IMPRINTING

Chroma-Bond Imprinting, 1 Color Logo Only

1COL25SF	Up to 25SF, MINIMUM SF: 20.5 SF	\$34/SF
1COL2650SF	26SF—50SF, MINIMUM SF: 37.55 SF	\$24/SF
1COL51100SF	51SF-100SF, MINIMUM SF: 66.5 SF	\$22/SF

Chroma-Bond Imprinting, 2 Color Logo Only

2COL25SF	Up to 25SF, MINIMUM SF: 20.5 SF	\$34/SF
2COL2650SF	26SF—50SF, MINIMUM SF: 37.55 SF	\$24/SF
2COL51100SF	51SF-100SF, MINIMUM SF: 66.5 SF	\$22/SF

Chroma-Bond Imprinting, 3 Color Logo Only

3COL25SF	Up to 25SF, MINIMUM SF: 20.5 SF	\$34/SF
3COL2650SF	26SF—50SF, MINIMUM SF: 37.55 SF	\$24/SF
3COL51100SF	51SF-100SF, MINIMUM SF: 66.5 SF	\$22/SF

Chroma-Bond Imprinting
Letters or Numbers

1 Color		2 Color	
1COL24	\$90/EA	Up to 24" Tall	2COL24 \$122/EA
1COL36	\$105/EA	36" Tall	2COL36 \$138/EA
1COL48	\$122/EA	48" Tall	2COL48 \$154/EA
1COL60	\$138/EA	60" Tall	2COL60 \$170/EA
1COL72	\$162/EA	72" Tall	2COL72 \$194/EA
1COL84	\$178/EA	84" Tall	2COL84 \$210/EA
1COL96	\$194/EA	96" Tall	2COL96 \$226/EA
1COL108	\$218/EA	108" Tall	2COL108 \$250/EA
1COL120	\$250/EA	120" Tall	2COL120 \$283/EA

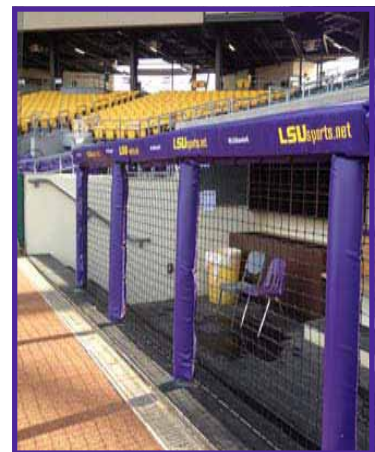

U-SHAPED WOOD BACKED RAIL PADS			
<i>(18 OZ. VINYL—18 COLORS)</i>			
WBUSHAPEX	U-Shaped Pad	LF	\$37.75
WBFLAT	Flat Pad	LF	\$25.35
WBUSHAPEHARDWARE	Hardware for U-Shaped Pad	SET	\$10.70
WBFLATHARDWARE	Hardware for Flat Pad	SET	\$2.15
VELCROWRAP	Velcro Wrap	LF	\$8.40

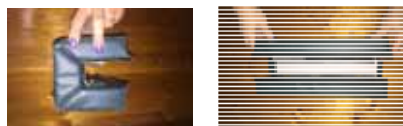

YOUR "ONE-STOP" SOURCE FOR AMERICA'S BASEBALL, SOFTBALL & SPORTS SURFACES & SUPPLIES!

PRICES SUBJECT TO CHANGE & AVAILABILITY PLUS SHIPPING | VOLUME DISCOUNTS AVAILABLE | COOPERATIVE PURCHASING CONTRACT PRICING FOR 50 STATES

Do-It-Yourself Top Rail/Dugout Padding

DIY Padding: Tubular Foam with core cut out to fit rail OD. 85 lb. ILD foam cut in lengths of 6' covered with 18 oz. outdoor vinyl cut to custom lengths with a reinforced hem along length, double stitched with grommets every 6". Cut excess foam off and push extra vinyl into core for finished end and to protect foam from sunlight. Secure with ties or lacing twine.

Material: Foam wrapped in 18 oz Vinyl Colors: Green, Royal Blue, Yellow, White, Red, Black, Grey, and more.

BF4RP	4" Foam diameter (TO FIT UP TO 1" -1-5/8" DIA. POLE)	LF	\$16.50
BF45RP	4.5" Foam diameter (TO FIT UP TO 2" -2-1/2" DIA. POLE)	LF	\$17.50
BF5RP	5" Foam diameter (TO FIT UP TO 2-1/2" -3" DIA. POLE)	LF	\$20.50
BF55RP	5.5" Foam diameter (TO FIT UP TO 3" -3-1/2" DIA. POLE)	LF	\$24.50
LT300	#60 Lacing Twine 300' Spool	EA	\$25
PT-7.5BK	7-1/2" 50 LB. UV-Resistant Black Plastic Ties (Packs of 100)	PK	\$10
PT-HD8BK	8" 120 LB. Heavy-Duty UV-Resistant Black Plastic Ties (Packs of 100)	PK	\$16



YOUR "ONE-STOP" SOURCE FOR AMERICA'S BASEBALL, SOFTBALL & SPORTS SURFACES & SUPPLIES!

PRICES SUBJECT TO CHANGE & AVAILABILITY PLUS SHIPPING | VOLUME DISCOUNTS AVAILABLE | COOPERATIVE PURCHASING CONTRACT PRICING FOR 50 STATES

PRIVACY DECORATIVE SLATS (PDS®) FOR CHAIN LINK FENCING



Made in the USA: Be aware of some non-USA made fence slats that may fade and discolor. Our PDS® slats are made of virgin High Density Polyethylene (HDPE) are made in the USA and have UV inhibitors (UV resistant color concentrates) to add color protection and guard against cracking, chalking, and fading in the sunlight.

Durability: Our PDS® slats are resistant to: severe weather conditions, salt water, sand, road dirt, most acids, alcohol, alkaline, ammonia, petroleum distillates and common environmental pollutants.



Standard Colors*



* Exact representation of slat colors in printing is difficult. Please refer to actual color samples for final matching.

* Special colors are available upon request. Minimum quantities apply.

* Made in the USA

ASTM

"Meets ASTM3000 and ASTM3000M specifications"

Materials

All except Hedgelink® are extruded from High Density Prime Polyethylene, color pigments and ultra violet (UV) inhibitors, specifically designed to retard the harmful effects of the sun and lengthen the life of the product.

Maintenance



Cleaning of most surface contaminants is quickly accomplished with plain water.

Wind Load Disclaimer

Seller/Manufacturer will not be responsible for fence damage resulting from wind load conditions due to insufficient structural support.

Limited Warranty

PDS® Fence Products carry an extensive, pro-rata warranty against breakage and material degradation under normal conditions.

WHAT SIZE PDS® FENCE SLATS WILL WORK IN YOUR CHAIN LINK FENCE?

The PDS® Fence products are available in a variety of Fence Privacy Slats (Inserts), which fit in different sizes of chain link fencing. We have Fence Slats that fit into the following diamond sizes: 1-3/4", 2", 2-1/4", 2-3/8" and 3-1/2" x 5".

Before you order Fence Slats, you must first determine the size of the "diamond" on your fence. This is done by measuring the inside dimensions diagonally in both directions. (See Photos Above)

Please note: The wire gauge (thickness), will affect the fit of our Fence Slats. Each product in this brochure includes a chart to show what size Fence Slat needs to be ordered for the various diamonds and gauge combinations available in the marketplace.

Above is a measurement of a 2" Chain Link Diamond.

YOUR "ONE-STOP" SOURCE FOR AMERICA'S BASEBALL, SOFTBALL & SPORTS SURFACES & SUPPLIES!

PRICES SUBJECT TO CHANGE & AVAILABILITY PLUS SHIPPING | VOLUME DISCOUNTS AVAILABLE | COOPERATIVE PURCHASING CONTRACT PRICING FOR 50 STATES

PRIVACY DECORATIVE SLATS (PDS®) FOR CHAIN LINK FENCING

Price per bag or box — 10 linear feet per bag or box.

Bottom Lock					
Length	Weight	Item#	1-599	Item#	600-1199
3'	7 #	BL7(?)L1	\$37	BL7(?)L2	\$32
3.5'	8 #	BL8(?)L1	\$42	BL8(?)L2	\$37
4'	9 #	BL9(?)L1	\$42	BL9(?)L2	\$37
5'	12 #	BL12(?)L1	\$53	BL12(?)L2	\$46
6'	14 #	BL14(?)L1	\$64	BL14(?)L2	\$55
7'	17 #	BL17(?)L1	\$74	BL17(?)L2	\$64
8'	19 #	BL19(?)L1	\$85	BL19(?)L2	\$74
10'	24 #	BL24(?)L1	\$106	BL24(?)L2	\$92
12'	29 #	BL29(?)L1	\$127	BL29(?)L2	\$111

- * Slat is 3 1/2" short of nominal length
- *(A) 2" mesh: 82 slats, (B) 2 1/4" mesh 78 slats, (C) 1 3/4" mesh: 100 slats per bag
- * 1 3/4" Mesh is your base (1-599) price plus 25% with no minimum quantity / No Returns.
- * Special colors > 50 bag min add 35%, 100 bags add 20% or 150 bags add 10% surcharge #PEXCTM
- * Extra Channel #EC 32¢/LF
- * Approximately 75% wind block
- * 25 year limited warranty

Winged Slat®					
Length	Weight	Item#	1-599	Item#	600-1199
3'	8 #	WS8L1	\$50	WS8L2	\$43
3.5'	9 #	WS9L1	\$57	WS9L2	\$49
4'	11 #	WS11L1	\$57	WS11L2	\$49
5'	13 #	WS13L1	\$71	WS13L2	\$61
6'	16 #	WS16L1	\$85	WS16L2	\$74
7'	18 #	WS18L1	\$99	WS18L2	\$86
8'	21 #	WS21L1	\$113	WS21L2	\$98

- * Slat is 2" short of nominal length / 82 slats per bag
- * For 9 or 11 gauge 2" mesh / Requires no Locking Channel
- * Fence of 8' or higher - double stack 1/2 heights
- * Special colors > 50 bag min add 35%, 100 bags add 20% or 150 bags add 10% surcharge #PEXCTM
- * Approximately 90% wind block
- * 25 year limited warranty

LiteLink®					
Length	Weight	Item#	1-599	Item#	600-1199
3'	4 #	LL4L1	\$30	LL4L2	\$26
3.5'	5 #	LL5L1	\$34	LL5L2	\$30
4'	6 #	LL6L1	\$34	LL6L2	\$30
5'	7 #	LL7L1	\$43	LL7L2	\$37
6'	9 #	LL9L1	\$51	LL9L2	\$44
7'	10 #	LL10L1	\$60	LL10L2	\$52
8'	11 #	LL11L1	\$68	LL11L2	\$59
10'	14 #	LL14L1	\$85	LL14L2	\$74
12'	17 #	LL17L1	\$102	LL17L2	\$89

- * Slat is 3 1/2" short of nominal length
- * One size fits both 2" and 2 1/4" mesh - 82 pcs per box
- * Special colors > 50 box min add 35%, 100 boxes add 20% or 150 boxes add 10% surcharge #PEXCTM
- * Extra Channel #EC 32¢/LF
- * Approximately 75% wind block
- * 7 year limited warranty

Top Lock					
Length	Weight	Item#	1-599	Item#	600-1199
3'	7 #	TL7(?)L1	\$38	TL7(?)L2	\$33
3.5'	8 #	TL8(?)L1	\$43	TL8(?)L2	\$37
4'	9 #	TL9(?)L1	\$43	TL9(?)L2	\$37
5'	12 #	TL12(?)L1	\$54	TL12(?)L2	\$47
6'	14 #	TL14(?)L1	\$65	TL14(?)L2	\$56
7'	17 #	TL17(?)L1	\$75	TL17(?)L2	\$66
8'	19 #	TL19(?)L1	\$86	TL19(?)L2	\$75
10'	24 #	TL24(?)L1	\$108	TL24(?)L2	\$94
12'	29 #	TL29(?)L1	\$129	TL29(?)L2	\$112

- * Slat is 2" short of nominal length
- *(A) 2" mesh: 82 slats, (B) 2 1/4" mesh 78 slats, (C) 1 3/4" mesh: 100 slats per bag
- * 2 1/4" and 1 3/4" mesh are base price (1-599) plus 25% with 50 bag min per color / No Returns.
- * Special colors > 50 bag min add 35%, 100 bags add 20% or 150 bags add 10% surcharge #PEXCTM
- * Extra Channel #EC 32¢/LF
- * 200ft Channel reel available #CR \$68/EA
- * Approximately 75% wind block
- * 25 year limited warranty

FinLink®					
Length	Weight	Item#	1-599	Item#	600-1199
3'	8 #	FL8L1	\$52	FL8L2	\$45
3.5'	9 #	FL9L1	\$59	FL9L2	\$51
4'	10 #	FL10L1	\$59	FL10L2	\$51
5'	12 #	FL12L1	\$74	FL12L2	\$64
6'	14 #	FL14L1	\$88	FL14L2	\$77
7'	16 #	FL16L1	\$103	FL16L2	\$90
8'	19 #	FL19L1	\$118	FL19L2	\$102

- * Slat is 3 1/2" short of nominal length
- * For 11 gauge 2" mesh ONLY - 82 slats per bag
- * Uses bottom channel for level installation
- * Extra Channel #EC 32¢/LF
- * Special colors > 50 bag min add 35%, 100 bags add 20% or 150 bags add 10% surcharge #PEXCTM
- * Approximately 90% wind block
- * 25 year limited warranty

HedgeLink®					
Length	Weight	Item#	1-599	Item#	600-1199
4'	17 #	HL17L1	\$122	HL17L2	\$112
5'	20 #	HL20L1	\$143	HL20L2	\$132
6'	25 #	HL25L1	\$175	HL25L2	\$160
7'	29 #	HL29L1	\$199	HL29L2	\$183
8'	33 #	HL33L1	\$224	HL33L2	\$205
10'	40 #	HL40L1	\$297	HL40L2	\$273

- * One size fits both 2" and 2 1/4" mesh
- * 10 linear feet per box / 82 Hedge-Slats per box
- * 16 gauge braided galvanized wire / 3-mil PVC green needles
- * DO NOT MIX Hedge-Link with any other hedge product
- * Approximately 95% wind block
- * 10 year limited warranty

Standard Colors*



YOUR "ONE-STOP" SOURCE FOR AMERICA'S BASEBALL, SOFTBALL & SPORTS SURFACES & SUPPLIES!

PRICES SUBJECT TO CHANGE & AVAILABILITY PLUS SHIPPING | VOLUME DISCOUNTS AVAILABLE | COOPERATIVE PURCHASING CONTRACT PRICING FOR 50 STATES

BOTTOM LOCK



Bottom Lock utilizes our innovative bottom locking channel system providing a “snap-in” locking effect for security and deters vandalism at an affordable price.

TOP LOCK



Top Lock utilizes a top-locking mechanism located near the top of the slats for easy installation and to ensure a clean, straight edge, enhancing its appearance.

Design: Bottom-Lock Slats are flat and tubular in shape, with two “legs” inside the rigid, hollow body of the slat, for extra durability.

Installation Instructions:

- Step 1** Insert locking channel horizontally in first full diamond at bottom of fence with open side facing up.
- Step 2** Insert vertical slats with beveled/notched end downward. Slat engages and interlocks with bottom rail.
- Step 3** Push the vertical slat into the horizontal channel to lock in place.

Standard Heights: 4, 5, 6, 7, 8, 10 and 12 feet. Special heights available upon request.

Wind Load and Privacy Factor: Approximately 75%.

Bottom-Locking Channel: 10 feet provided in each bag.

Slat Length: 3½” shorter than the overall height of fence.

Warranty: 25 years pro-rata.

SLAT PROFILE:



LOCKING CHANNEL:



Slat Type	Slat Width	Mesh Size	Wire Gauge	Slats Per Bag
Bottom Lock 2”	1½”	2”	8, 9 or 11	82
Bottom Lock 2¼”	1¼”	2¼” or 2½”	11½ or 12½	78
Bottom Lock 1¾”	7/8”	1¾”	8, 9 or 11	100
*Bottom Lock 1¼”	7/8”	2”	6	100

*Choosing this option will significantly decrease the privacy factor.

Design: Top-Lock Slats are flat and tubular in shape, with circular, notched-out holes located near the top of the slat.

Installation Instructions:

- Step 1** No need to kneel, simply insert the slats vertically from top to bottom, keeping the locking holes on top.
- Step 2** Thread the flexible locking channel horizontally through the notched holes in the slats. These holes are elliptical to ensure they always stay open for fast and easy threading.
- Step 3** For extra security, insert a pop-rivet through locking channel and one slat.

Standard Heights: 4, 5, 6, 7, 8, 10 & 12 feet. Special heights available upon request.

Wind Load and Privacy Factor: Approximately 75%.

Top-Locking Channel: 10 feet provided in each bag.

Slat Length: 2” shorter than the overall height of fence.

Warranty: 25 years pro-rata.

SLAT PROFILE:

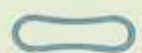

Slat Type	Slat Width	Mesh Size	Wire Gauge	Slats Per Bag
Top Lock 2”	1½”	2”	8, 9 or 11	82
Top Lock 2¼”	1¼”	2¼” or 2½”	11½ or 12½	78
Top Lock 1¾”	7/8”	1¾”	8, 9 or 11	100
*Top Lock 1¼”	7/8”	2”	6	100

*Choosing this option will significantly decrease the privacy factor.

YOUR “ONE-STOP” SOURCE FOR AMERICA’S BASEBALL, SOFTBALL & SPORTS SURFACES & SUPPLIES!

PRICES SUBJECT TO CHANGE & AVAILABILITY PLUS SHIPPING | VOLUME DISCOUNTS AVAILABLE | COOPERATIVE PURCHASING CONTRACT PRICING FOR 50 STATES



With the proven quality and durability of our standard slats, plus unique flexible "wings" for extra screening and security, Winged Slats® are self-locking - no locking channels are needed!

The FinLink® slat offers extra screening and security with a unique configuration of (3) three privacy fins.

Design: Our innovative Winged Slat has a rigid, flat-tubular body, with two "legs" inside the rigid, hollow body of the slat for extra support and durability. Flexible and resilient wing portions are positioned on each side of the slat body. Serrations are added to the wings for easier installation and locking power.

Installation Instructions: Insert vertical slats with angle cut end downward. Winged portion interlocks with chain link fence knuckles.

Standard Heights: 4, 5, 6, 7 and 8 feet.

Important: For Fence heights higher than 8 feet, we strongly advise **NOT** to double-stack Winged Slats®. If you double-stack, you will be at risk of the Winged Slats® not all giving the same visual appearance or giving the same privacy effect on the top and bottom portions of the Fence.

Wind Load and Privacy Factor: Approximately 90%. (Based on wire/mesh used - stretch tension)

Slat Length: 2" shorter than the overall height of fence.

Warranty: 25 years pro-rata.



Design: Our unique innovative design includes a rigid, flat tubular body, with a "leg" inside the rigid, hollow body of the slat for extra support. Three flexible fins (two on one side and one on the other) are positioned on the sides of the slat body. The FinLink® fins are not serrated, thus providing a smooth finished look.

Installation Instructions:

Step 1 Insert locking channel horizontally in first full diamond at bottom of fence with open side facing up.

Step 2 Insert vertical slats with bevel end downward.

Step 3 Push the vertical slat into the horizontal channel until the slat touches the bottom of channel.

Standard Heights: 4, 5, 6, 7 and 8 feet.

Wind Load and Privacy Factor: Approximately 90%.

Bottom-Locking Channel: 10 feet provided in each bag.

Slat Length: 3½" shorter than the overall height of fence.

Warranty: 25 years pro-rata.



Slat Type	Slat Width	Mesh Size	Wire Gauge	Slats Per Bag
Winged Slat®	1¾"	2"	9 only	82

Slat Type	Slat Width	Mesh Size	Wire Gauge	Slats Per Bag
FinLink®	1¾"	2", 2¼" or 2½"	11	82

YOUR "ONE-STOP" SOURCE FOR AMERICA'S BASEBALL, SOFTBALL & SPORTS SURFACES & SUPPLIES!

PRICES SUBJECT TO CHANGE & AVAILABILITY PLUS SHIPPING | VOLUME DISCOUNTS AVAILABLE | COOPERATIVE PURCHASING CONTRACT PRICING FOR 50 STATES



LiteLink® is a single wall "M" shaped slat that gives visual screening and color enhancement at our most affordable price. It also uses our innovative Bottom-Locking Channel system.

Design: Compact and lightweight, LiteLink®'s unique shape enables the slat to self stack. It comes packaged in a box (2" x 5" x Slat Length), making it easy to ship and efficient to store.

Installation Instructions:

Step 1 Insert locking channel horizontally in first full diamond at bottom of fence with open side facing up.

Step 2 Insert vertical slats with interlocking tab downward. Slat engages and interlocks with bottom rail.

Step 3 Push the vertical slat into the horizontal channel to lock in place.

Standard Heights: 4, 5, 6, 7, 8, 10 and 12 feet. Special heights available upon request.

Wind Load and Privacy Factor: Approximately 75%.

Slat Length: 3½" shorter than the overall height of fence.

Warranty: 7 years pro-rata.



Slat Type	Slat Width	Mesh Size	Wire Gauge	Slats Per Box
LiteLink®	1¼"	2", 2¼" or 2¾"	9, 11 or 11½	82

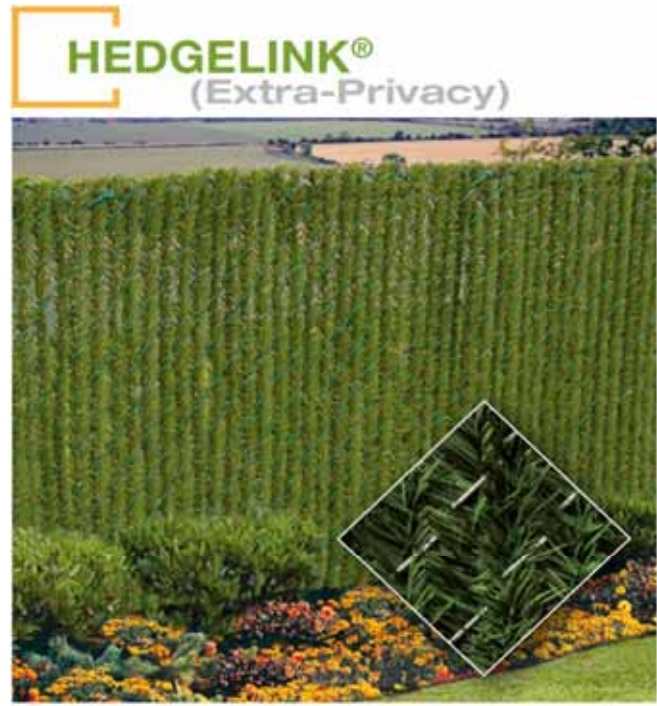

HedgeLink® is our most premium and unique chain link fence enhancement product, which creates a natural green hedge look that requires no maintenance and offers almost complete privacy.

Design: The HedgeLink® core is made with a strong, rigid 16-gauge galvanized, braided wire. Blue Spruce colored 3-mil PVC needles are embossed for an extra plush effect.

Installation Instructions: Requires no locking device or tools and installs much like our Winged Slats®. Insert HedgeLink® slats vertically top to bottom, keeping the green needles facing up, while revolving the slat clockwise with your fingers for easier installation.

Standard Heights: 4, 5, 6, 7, and 8 feet.

Wind Load and Privacy Factor: Approximately 95%.

Fence Sizes: For most Chain Link Fence sizes. Not intended for use with mini-mesh or 3½" x 5" fence fabric.

Features: UV stabilized to protect against the harmful rays of the sun. Flame retardant.

Note: Do not mix HedgeLink® with any other manufacturer's hedge product – color shades are different.

Warranty: 10 years pro-rata.

Slat Type	Mesh Size	Wire Gauge	Slats Per Box	Approx. Coverage Per Box
HedgeLink®	2", 2¼" or 2¾"	9, 11 or 11½	82	10 linear ft

YOUR "ONE-STOP" SOURCE FOR AMERICA'S BASEBALL, SOFTBALL & SPORTS SURFACES & SUPPLIES!

PRICES SUBJECT TO CHANGE & AVAILABILITY PLUS SHIPPING | VOLUME DISCOUNTS AVAILABLE | COOPERATIVE PURCHASING CONTRACT PRICING FOR 50 STATES